

# PPC2-CW19-EHL

## IEI Heavy Industrial Panel PC

Powered by Intel® Elkhart Lake Platform



[www.ieiworld.com](http://www.ieiworld.com)



# PPC2-CW19-EHL

Panel PC equips Intel® Celeron® J6412 processor, on-board 8GB memory, HDMI display output, dual 2.5G Ethernet port, one M.2 M key & one M.2 B key expansion slots, 12~24V DC input, anti-glare and anti-UV 10-point touchscreen



## IP2EHL\_XC Expansion Interface

The IP2EHL\_XC connector allows users to flexibly expand functionality such as network, serial ports and CAN to meet various application requirements. (IEI-designed pin definition, supported functions are customized, for models of 10-inch or above)

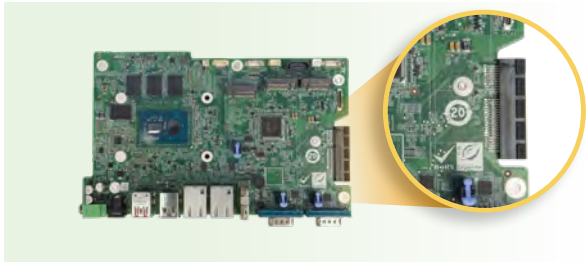

## M.2 B Key & M.2 M Key

Dual M.2 ultra-high-speed expansion supporting SSD & AI accelerator to enhance efficiency

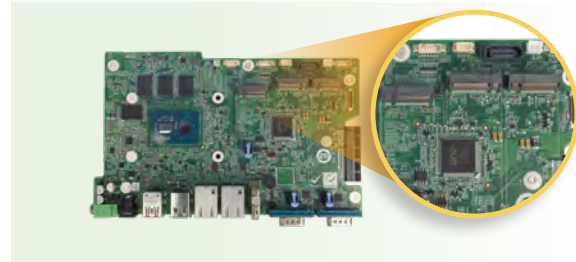

## Anti-glare and Anti-UV PCAP

With anti-glare and anti-UV coating, the 10-point touchscreen can display clearly without reflection for a long time use in outdoors and bright light environment.



## Support Gloved and Wet Hand Operation

The whole new PCAP screen allows you to accurately manage every step of your operations even with gloves or in wet conditions.



## Newly Designed Panel Mount Kit

The new refined and convenient panel mount kit can be easily fastened by hand, no screwdriver required.



## New Graphical BIOS Interface

Upgraded with new BIOS interface, which can be navigated with fingers, no keyboard and mouse are required to operate.

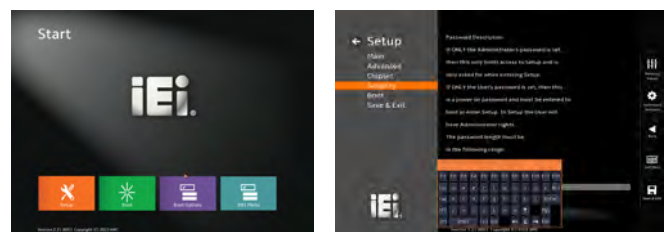

## Fully Integrated I/O

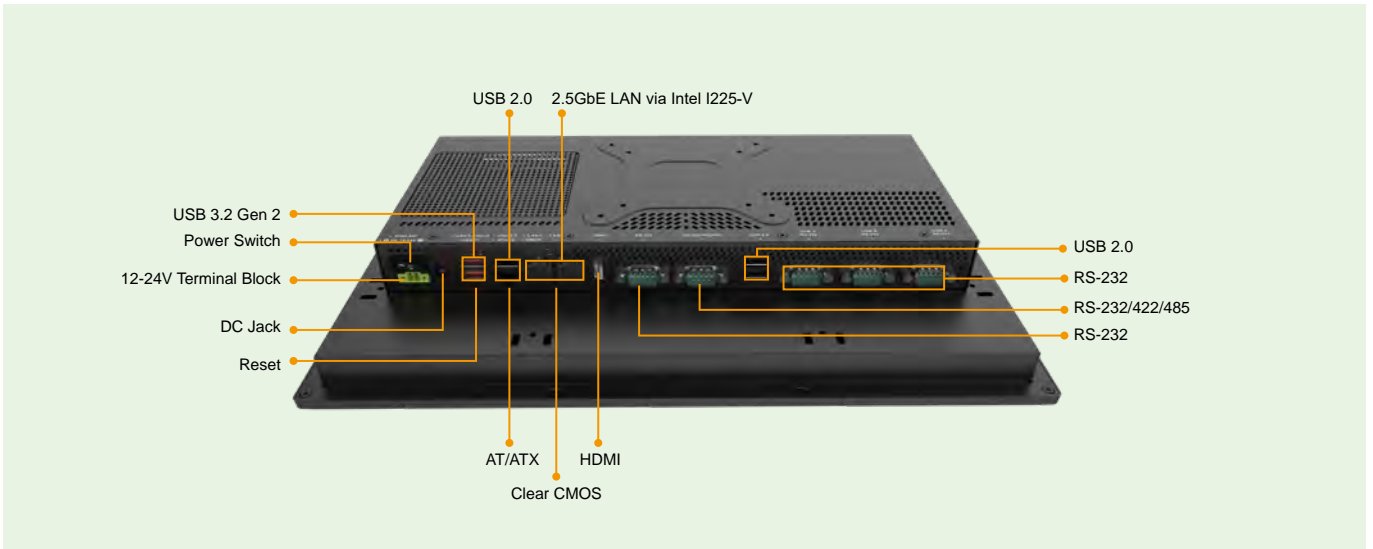

## Block Diagram

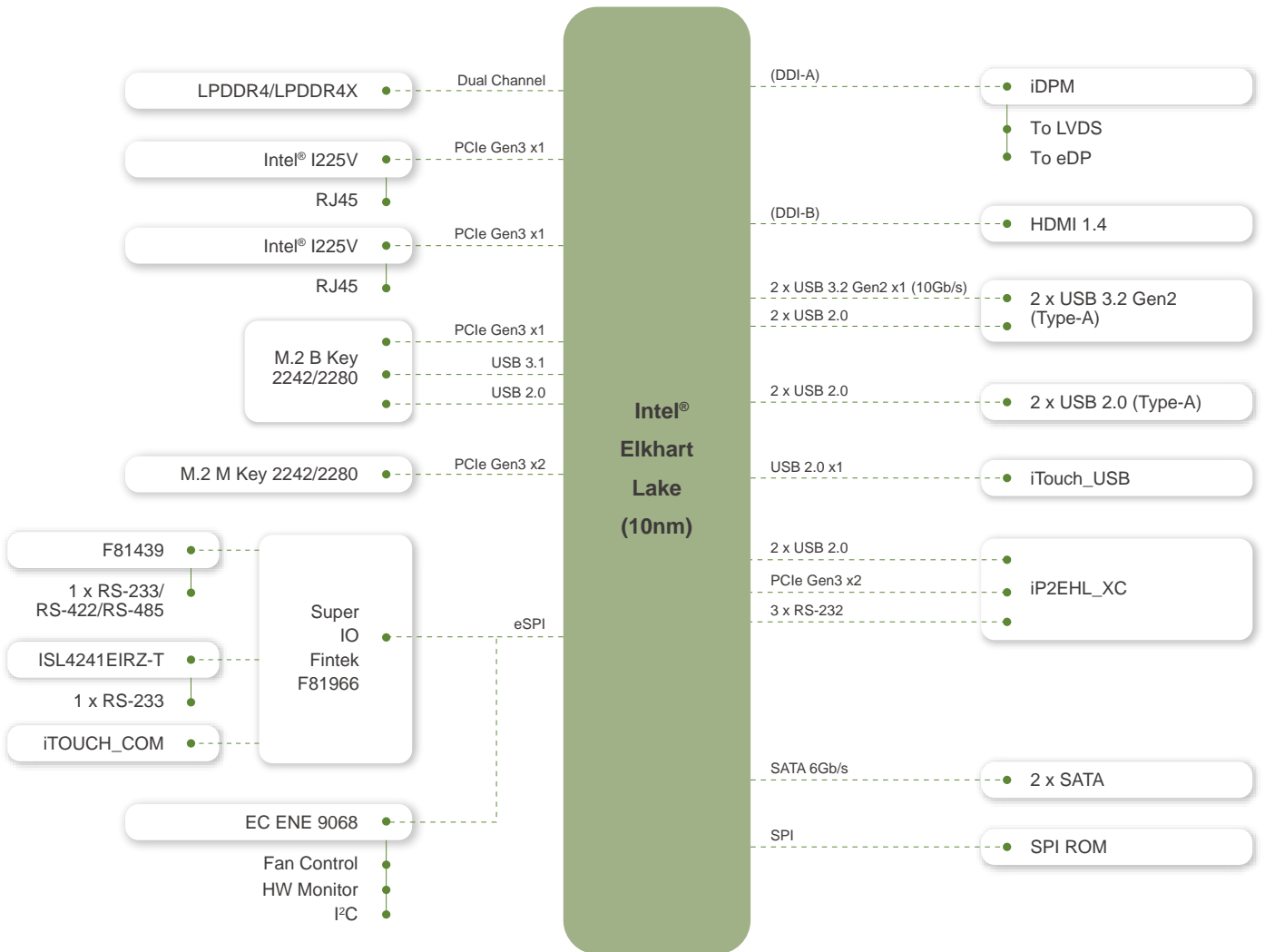

## Dimensions (Unit: mm)

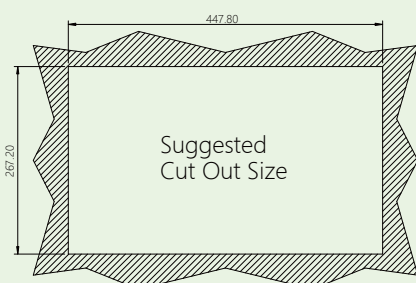
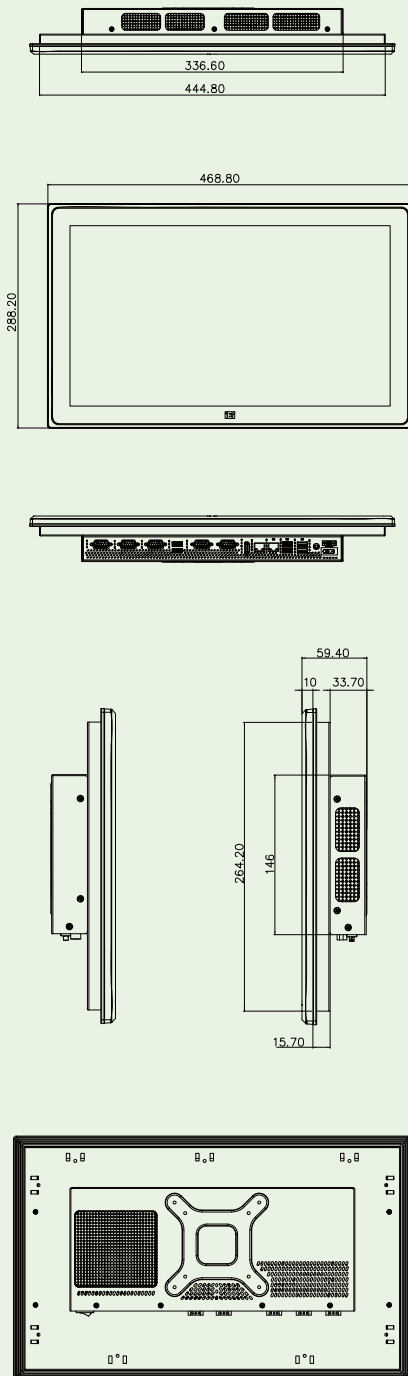

## Specifications

PPC2-CW19-EHL	
LCD Display	18.5" (16:9)
Resolution	1920 (W) x 1080 (H)
Brightness	400cd/cm <sup>2</sup>
Contrast Ratio	1000:1
LCD Color	16.7M
Pixel Pitch (mm)	0.3 x 0.3
Viewing Angle (H-V)	170°/160°
Backlight MTBF	50000
SBC Model	PPC2MB2-EHL-RC-R10+ PPC2-XIO-02-R10
CPU (SoC)	Intel® Celeron® Processor J6412 1.5M Cache, up to 2.60 GHz / TDP 10w
Memory	8GB dual-channel on-board LPDDR4/LPDDR4X
Touchscreen	Multi-point projected capacitive type (anti-UV / anti-glare coating, support gloves) Surface hardness: ≥7H
Touch Controller	Projected capacitive type: EETI 80
Storage	1 x 2.5" HDD/SSD drive bay
Ethernet	2 x 2.5GbE LAN via Intel I225-V
Expansion	1 x M.2 2242/2280 B key (PCIe Gen3 x1 + USB 3.0) 1 x M.2 2242 M key (PCIe Gen3 x2)
Mounting	VESA 100 mm x 100 mm Panel, Wall, Rack, Stand and Arm
Construction Material	Aluminum front cover and sheet metal rear cover
Enclosure Color	Black
I/O Ports, Switches and Buttons	1 x HDMI output 2 x RJ-45 GbE 2 x USB 3.2 Gen 2x1 (10Gb/s) 2 x USB 2.0 1 x RS-232/422/485 1 x RS-232 1 x 12V-24V power jack 1 x Power terminal block (2-pin) 1 x AT/ATX switch 1 x Power button 1 x Reset button 1 x Clear CMOS button PPC2-XIO-02-R10: 2 x USB 2.0 3 x RS-232 DB9 1 x M.2 B key 2242/2280 (PCIe Gen3 x 2 + USB 2.0)
Power Input	12 V ~ 24 V DC
Power Adapter	60W power adapter
Power Consumption	TBD
Thermal Solution	Fanless
TPM	Intel® Platform Trust Technology
Watchdog Timer	Software Programmable support 1~255 sec. system reset
Operating Temperature (with air flow)	-10°C ~ 60°C
Storage Temperature	-20°C ~ 60°C
Humidity	10% ~ 95%, non-condensing
IP Level	IP 65 compliant front panel
Safety and EMC	CE, FCC Class A
ErP	ErP 2009/125/EC
Dimensions (H x W x D) (mm)	468.80 x 288.20 x 59.40
Net Weight	TBD

## Packing List

1 x Power Cord	1 x Power Adapter	1 x QIG
1 x Panel Mount Kit	1 x Screw Pack (SATA)	

## Ordering Information

PPC2-CW19-EHL- J1/8G-R10	18.5" 400 cd/cm <sup>2</sup> 1366x768 Panel PC with Intel® Celeron® Processor J6412, 8GB LPDDR4 on-board, TDP 10W, HDMI output, black, 12-24V DC input, projected capacitive touchscreen with AG, R10
-----------------------------	---

## Options

Item	Part No	Description
Arm	ARM-11-RS/ARM-31-RS	VESA 75/100 Desk ARM
Stand	STAND-C12-R10	VESA 75/100 Easy Stand
Wall Mount Kit	AFLWK-12/AFLWK-19B	Monitor Wall mounting kit
OS	WIN10-IOTE2019-V-RS	Win10 IoT Ent LTSC 2019 MultiLang OEI Value